

Installation sanleitung
Installation Instruction
Instruction d'installation

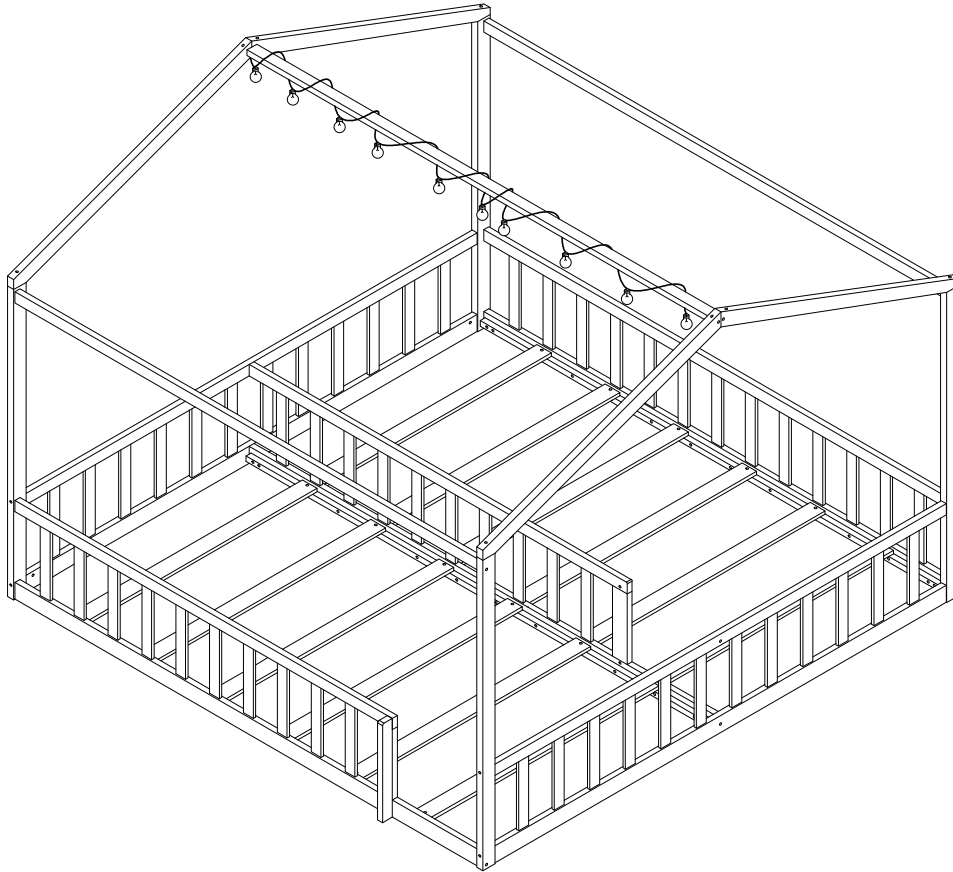

CE



FR
Cet appareil,
ses cordons,
et batterie
se recyclent

À DÉPOSER
EN MAGASIN

À DÉPOSER
EN DÉCHÈTERIE

OU

Points de collecte sur www.quefairedemesdechets.fr
Privilégiez la réparation ou le don de votre appareil !

N636P382007

English

IMPORTANT ! KEEP FOR FUTURE REFERENCE : READ CAREFULLY

- To be assembled by an adult. Assembly must be checked by an adult before use
 - WARNING ! Keep all screws, small parts and plastic bags out of the reach of children
 - Properly identify all parts before assembling
 - Never use your item if any of its parts are broken or missing
 - Should any problems arise, please contact our After Sales Service
 - Manufacturer's instructions shall be followed at all times
 - Care: Clean with a soft, dry cloth. In case of larger stains, carefully rub with a slightly damp, non-abrasive sponge
 - Avoid the risk of fire by not placing furniture near sources of ignition or hot items
- Do not jump on the bed

Deutsch

WICHTIG ! ZUM SPÄTEREN NACHSCHLAGEN AUFBEWAHREN: SORGFÄLTIG LESEN

- Muss von einem Erwachsenen zusammengebaut werden. Der Zusammenbau muss vor dem Gebrauch von einem Erwachsenen überprüft werden
 - WARNUNG! Bewahren Sie alle Schrauben, Kleinteile und Plastikbeutel außerhalb der Reichweite von Kindern auf
 - Kennzeichnen Sie vor dem Zusammenbau alle Teile richtig
 - Benutzen Sie Ihren Artikel niemals, wenn Teile gebrochen sind oder fehlen
 - Sollten Probleme auftreten, wenden Sie sich bitte an unseren Kundendienst
 - Die Anweisungen des Herstellers sind stets zu befolgen
 - Pflege: Mit einem weichen, trockenen Tuch reinigen. Bei größeren Flecken vorsichtig mit einem leicht feuchten, nicht scheuernden Schwamm abreiben. nicht scheuernden Schwamm
 - Vermeiden Sie die Gefahr eines Brandes, indem Sie die Möbel nicht in der Nähe von Zündquellen oder heißen Gegenständen aufstellen
- Nicht auf das Bett springen

Français

IMPORTANT ! CONSERVER POUR RÉFÉRENCE ULTÉRIEURE : LIRE ATTENTIVEMENT

- Le montage doit être effectué par un adulte. Le montage doit être vérifié par un adulte avant Utilisation
 - ATTENTION ! Tenir les vis, les petites pièces et les sachets en plastique hors de portée des enfants
 - Identifiez correctement toutes les pièces avant de les assembler
 - N'utilisez jamais votre article si l'une de ses pièces est cassée ou manquante
 - En cas de problème, veuillez contacter notre service après-vente
 - Les instructions du fabricant doivent être respectées à tout moment
 - Entretien : nettoyer avec un chiffon doux et sec. En cas de taches plus importantes, frotter soigneusement avec une éponge non abrasive légèrement humide. légèrement humide et non Abrasive
 - Évitez les risques d'incendie en ne plaçant pas les meubles à proximité de sources d'inflammation ou d'objets chauds
- Ne pas sauter sur le lit

Italiano

IMPORTANTE! CONSERVARE PER RIFERIMENTO FUTURO: LEGGERE ATTENTAMENTE

- Deve essere assemblato da un adulto. L'assemblaggio deve essere controllato da un adulto prima dell'uso
- **ATTENZIONE!** Tenere tutte le viti, le piccole parti e i sacchetti di plastica fuori dalla portata dei bambini
- Identificare correttamente tutte le parti prima dell'assemblaggio
- Non utilizzare mai l'articolo se alcune parti sono rotte o mancanti
- In caso di problemi, si prega di contattare il nostro Servizio Post Vendita
- Le istruzioni del produttore devono essere sempre seguite
- Cura: Pulire con un panno morbido e asciutto. In caso di macchie più estese, strofinare accuratamente con una spugna leggermente umida e nonspugna leggermente umida e non abrasiva
- Evitare il rischio di incendio, non collocando i mobili vicino a fonti di accensione o a oggetti caldi
- Non saltare sul letto

Español

¡ IMPORTANTE ! CONSERVELO PARA FUTURAS CONSULTAS: LEA ATENTAMENTE

- Debe ser montado por un adulto. El montaje debe ser comprobado por un adulto antes del uso
- ADVERTENCIA** Mantenga todos los tornillos, piezas pequeñas y bolsas de plástico fuera del alcance de los niños.
- Identifique correctamente todas las piezas antes de montarlas
 - Nunca utilice su artículo si alguna de sus piezas está rota o falta
 - Si surge algún problema, póngase en contacto con nuestro Servicio Postventa
 - Las instrucciones del fabricante deben seguirse en todo momento
 - Cuidado: Limpiar con un paño suave y seco. En caso de manchas más grandes, frote cuidadosamente con una esponja no abrasiva ligeramente humedecida.
 - Evite el riesgo de incendio no colocando los muebles cerca de fuentes de ignición u objetos calientes.
 - No saltar sobre la cama.

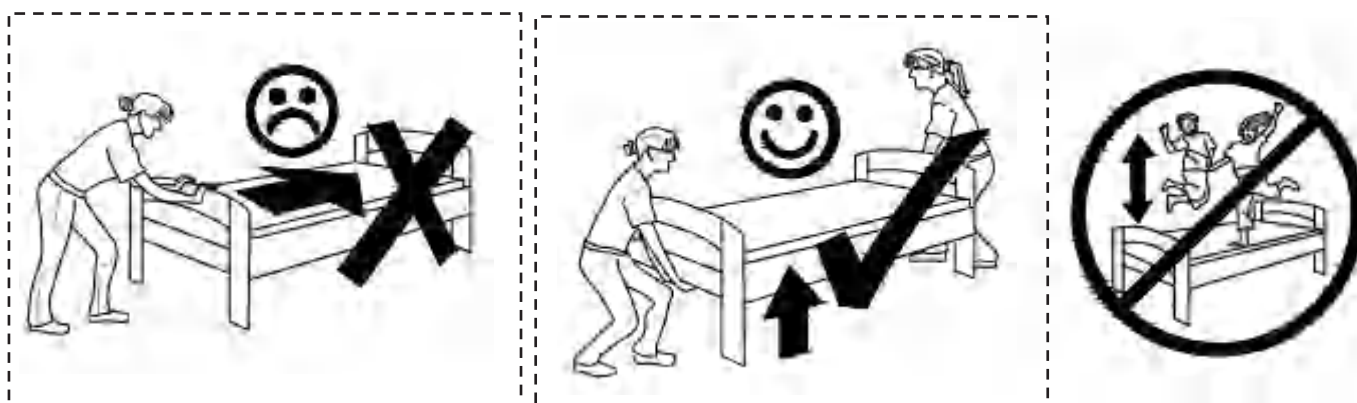

DE:Vor dem Einbau die Schrauben in die Löcher stecken und festziehen, aber nicht bis 100%, 70% bis 80% anziehen reicht aus. Schließlich, nachdem alle Schrauben installiert sind, ziehen Sie alle Schrauben auf 100%.
Wenn Sie auf diese Probleme stoßen, wie z. B. Fehlausrichtung der Löcher oder Unfähigkeit, bestimmte Teile zu installieren, überprüfen Sie bitte, ob die Schrauben korrekt verwendet werden und passen Sie die Dichtigkeit der Schrauben an.

UK:Before installation, insert the screws into the holes and tighten them, but do not tighten them to 100%, 70% to 80% is sufficient.Finally, after all screws are installed, tighten all screws to 100%.
If you encounter these issues, such as if the holes cannot be aligned or some parts cannot be installed, please check if the screws are used correctly and adjust the tightness of the screws.

FR:Insérer la vis dans le trou avant la fin de l'assemblage, serrer la vis, mais ne pas serrer à 100%, 70% ~ 80% est correct. Enfin, une fois que toutes les vis sont bien serrées, toutes les vis sont serrées à 100%.
Si vous rencontrez ces problèmes, par exemple si les trous ne sont pas alignés ou si certaines pièces ne peuvent pas être montées, vérifiez que les vis sont utilisées correctement et Ajustez leur serrage.

DE:Bitte beachten Sie, dass die Formen der Schrauben A und B und C ähnlich sind. Bitte installieren Sie entsprechend der Anleitung und unterscheiden Sie sie!

UK>Please note that the shapes of screws A and B and C are similar. Please install according to the instructions and distinguish them!

FR:Notez que les vis A et B et c ont des formes similaires. Veuillez les installer en suivant les instructions pour les séparer!

MONTAGEANLEITUNG/ASSEMBLY INSTRUCTIONS

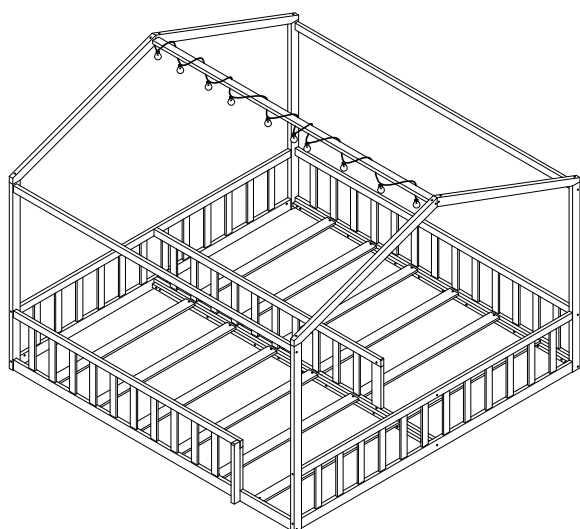
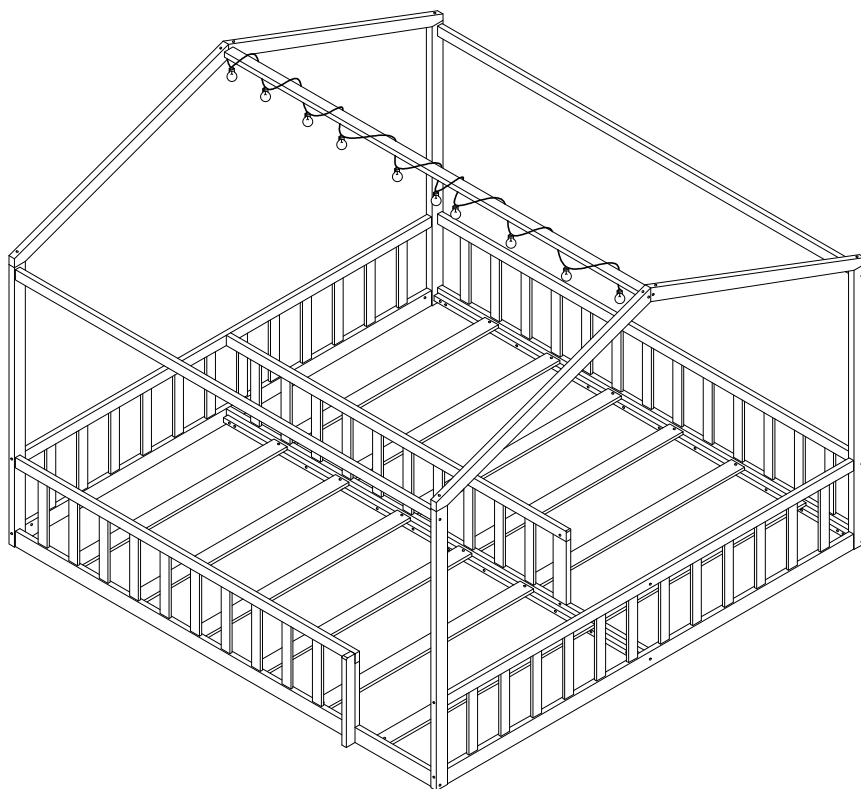

(version1)

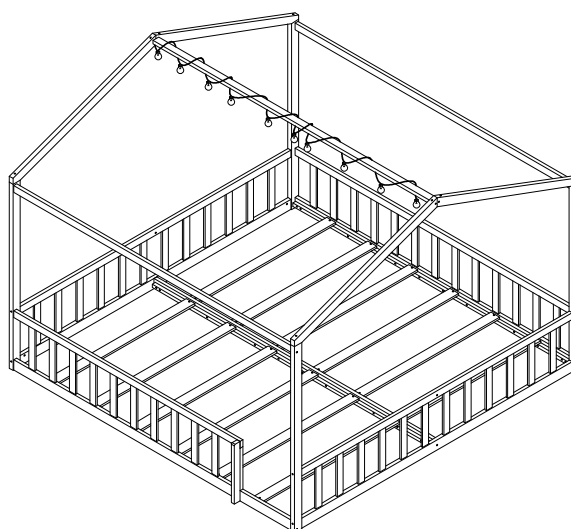





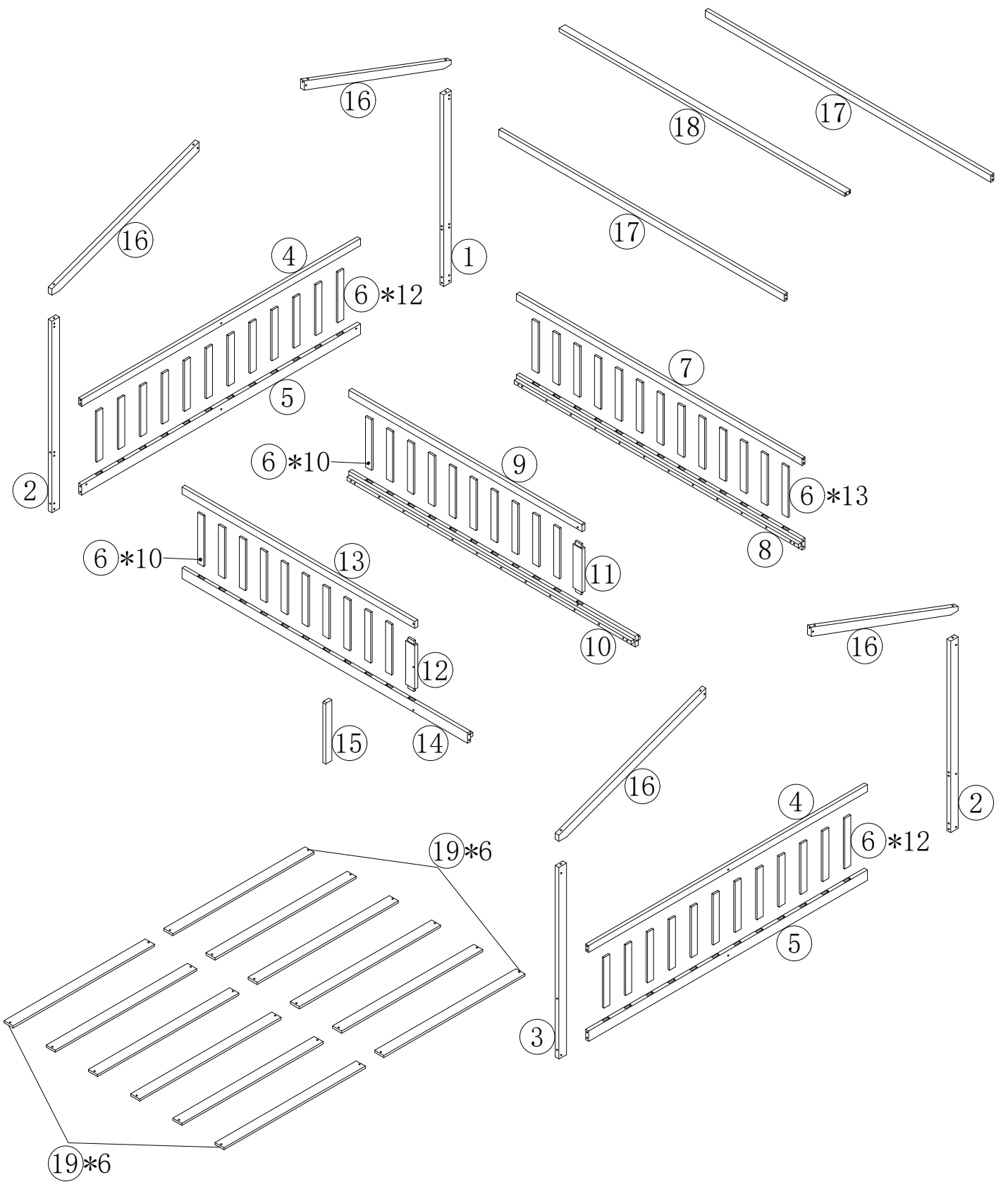





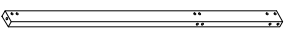

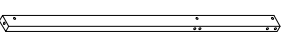

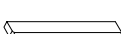

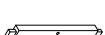

(version2)

MONTAGEANLEITUNG/ASSEMBLY INSTRUCTIONS















MONTAGEANLEITUNG/ASSEMBLY INSTRUCTIONS

N636P382007

1		1PC	11		1PC
2		2PCS	12		1PC
3		1PC	13		1PC
4		2PCS	14		1PC
5		2PCS	15		1PC
6		57PCS	16		4PCS
7		1PC	17		2PCS
8		1PC	18		1PC
9		1PC	19		12PCS
10		1PC			

N636P382007

A	6x90		4PCS	H	6x90		4PCS
B	6x70		4PCS	I	6x70		18PCS
C			8PCS	J	4x16		2PCS
D	Ø8x30		18PCS	K			1PC
E	6x20		2PCS	Q	3x25		24PCS
F	6x30		5PCS	S	M4		2PCS

MONTAGEANLEITUNG/ASSEMBLY INSTRUCTIONS

1

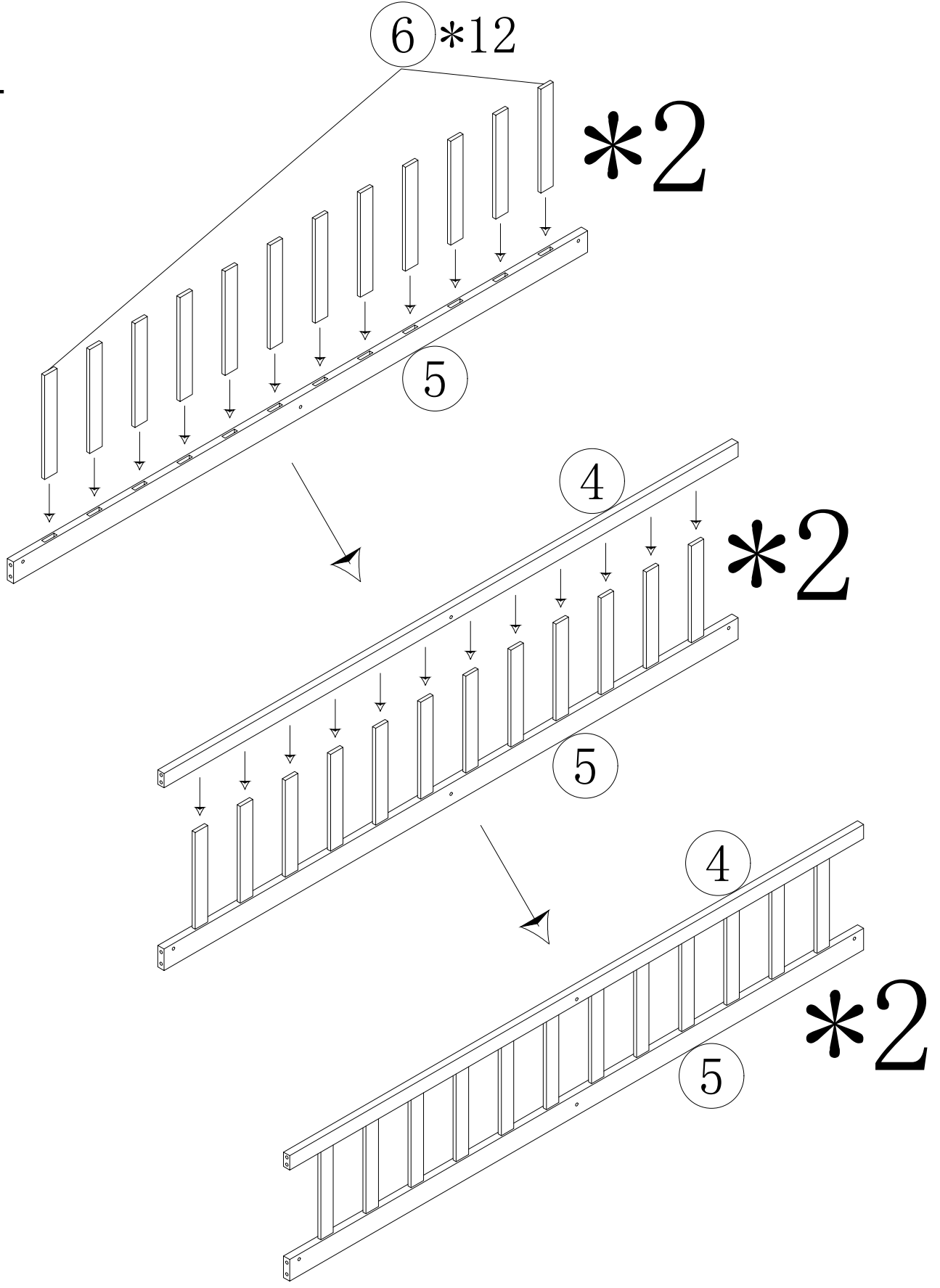

MONTAGEANLEITUNG/ASSEMBLY INSTRUCTIONS

2

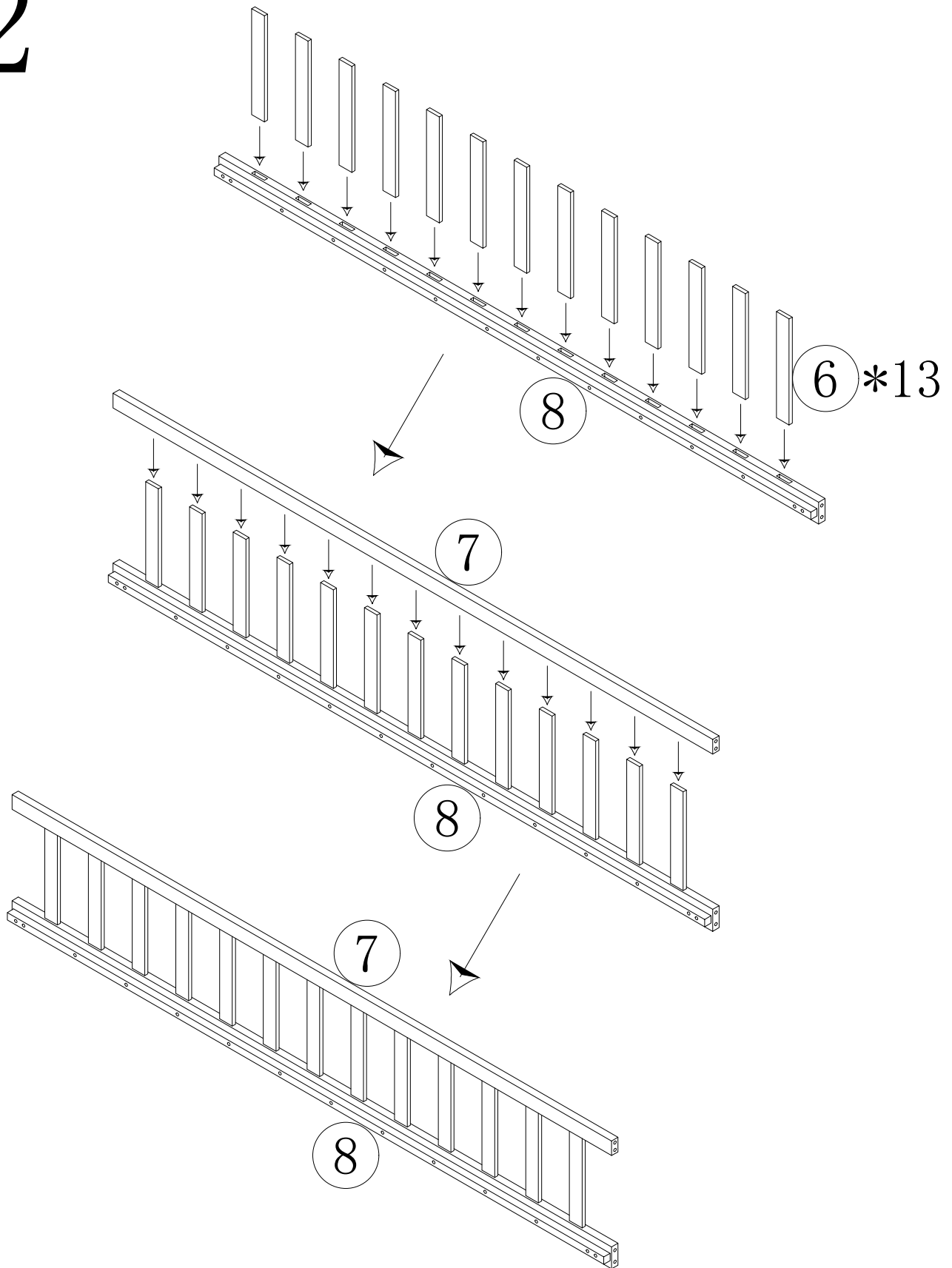

MONTAGEANLEITUNG/ASSEMBLY INSTRUCTIONS

3

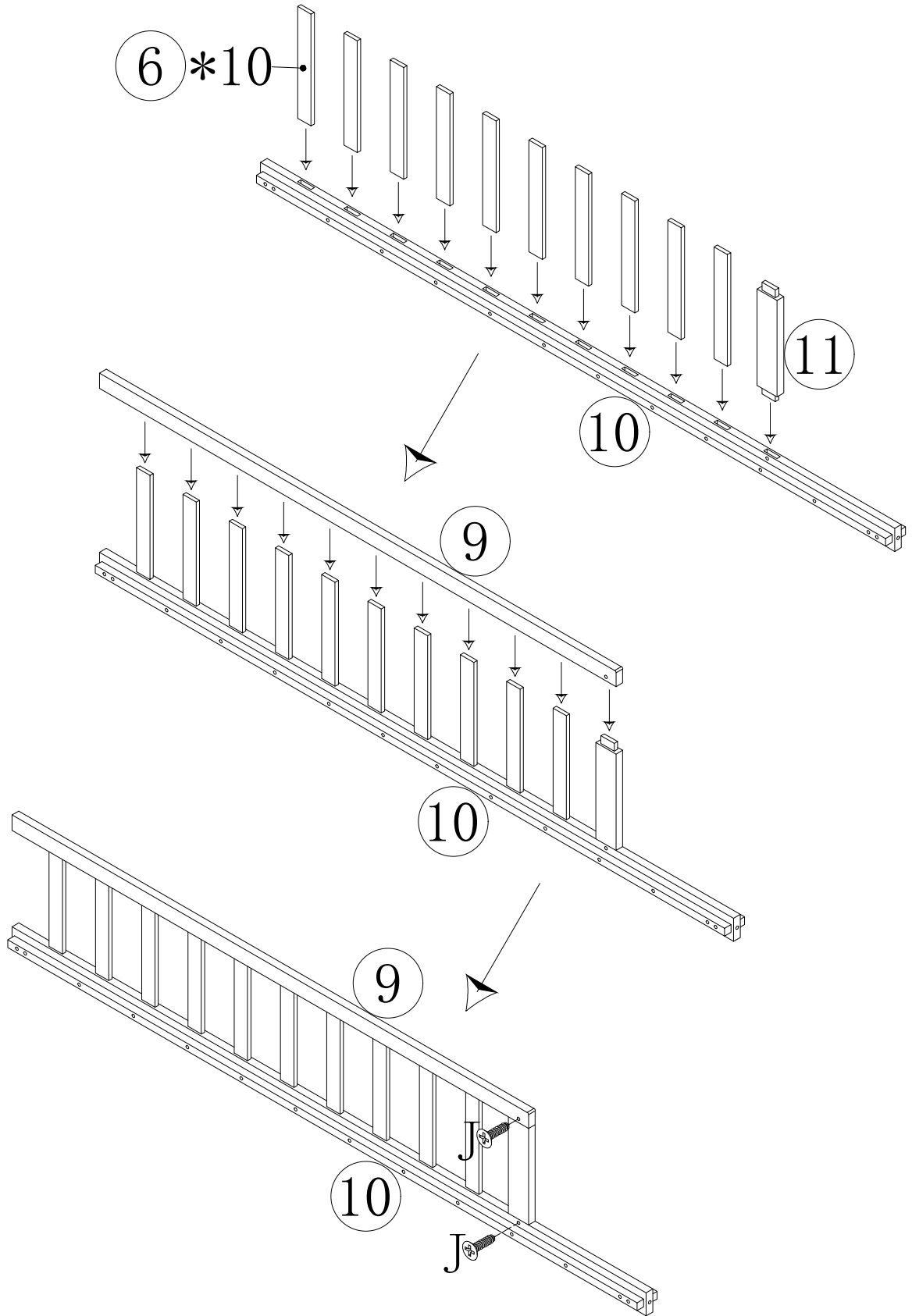

J	4x16		2PCS
---	------	---	------

MONTAGEANLEITUNG/ASSEMBLY INSTRUCTIONS

4

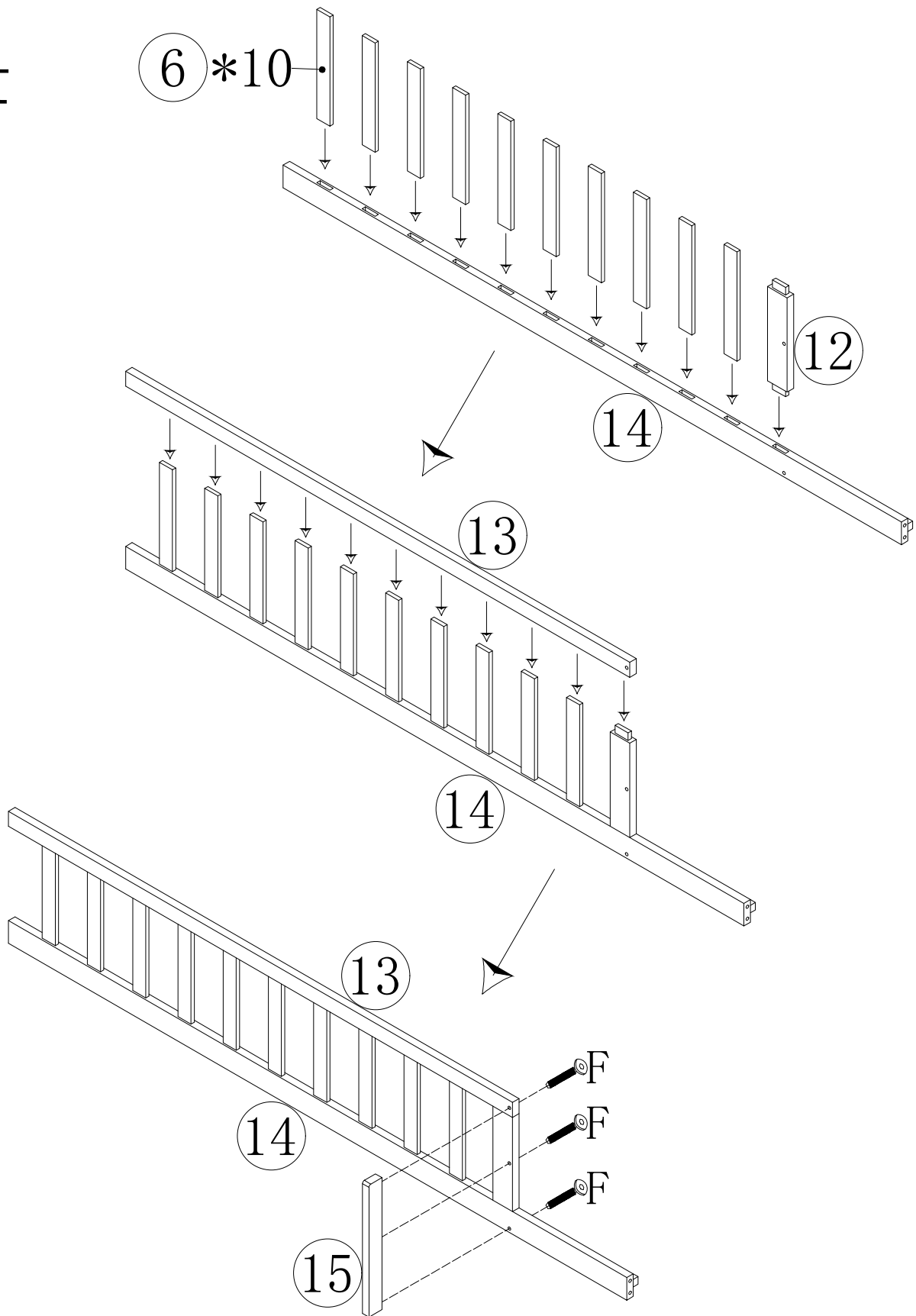

F	6x30		3PCS	S	M4		1PC
---	------	---	------	---	----	---	-----

MONTAGEANLEITUNG/ASSEMBLY INSTRUCTIONS

5

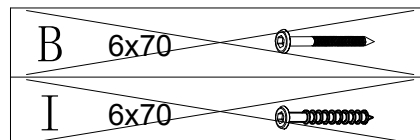
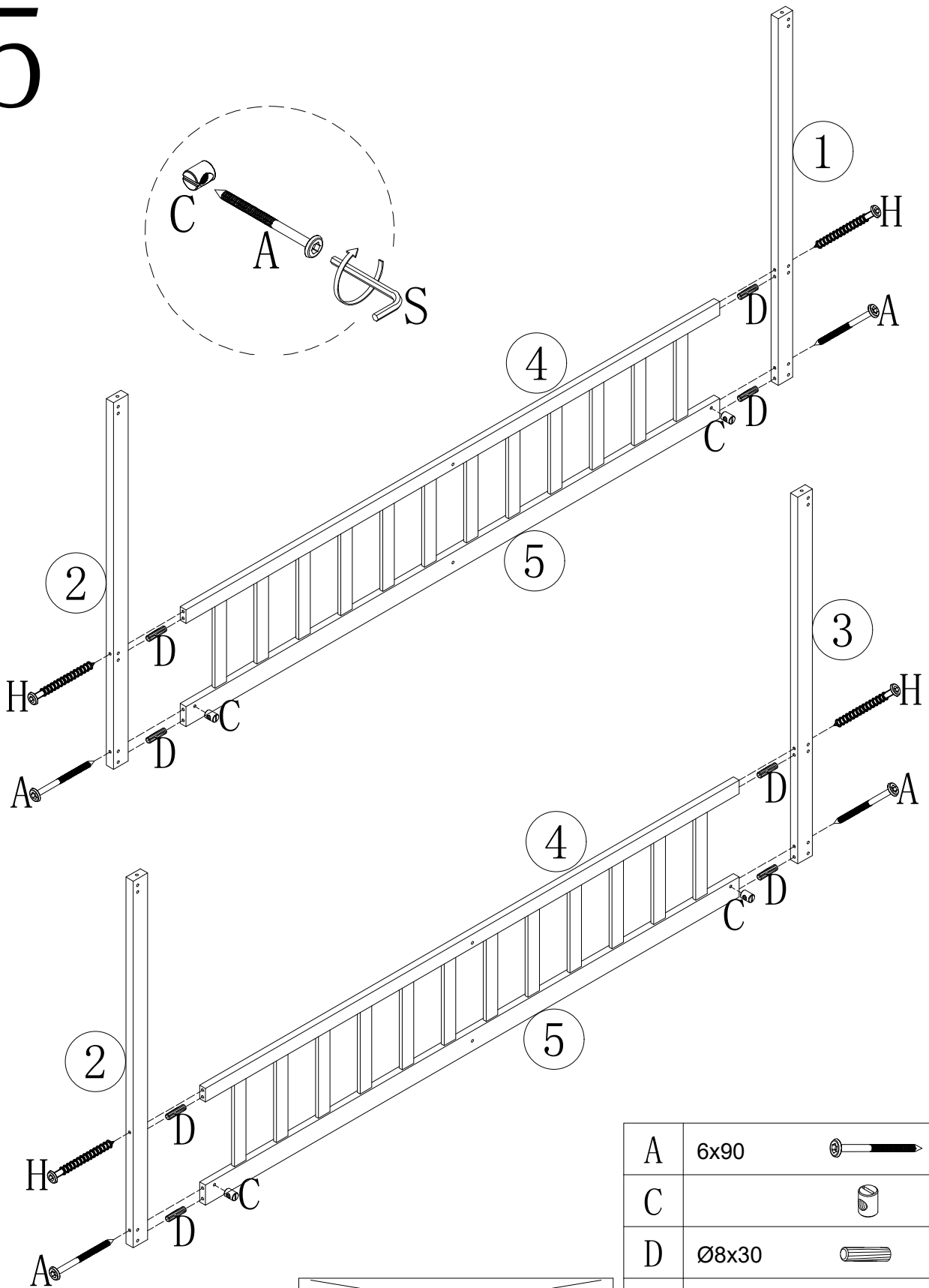





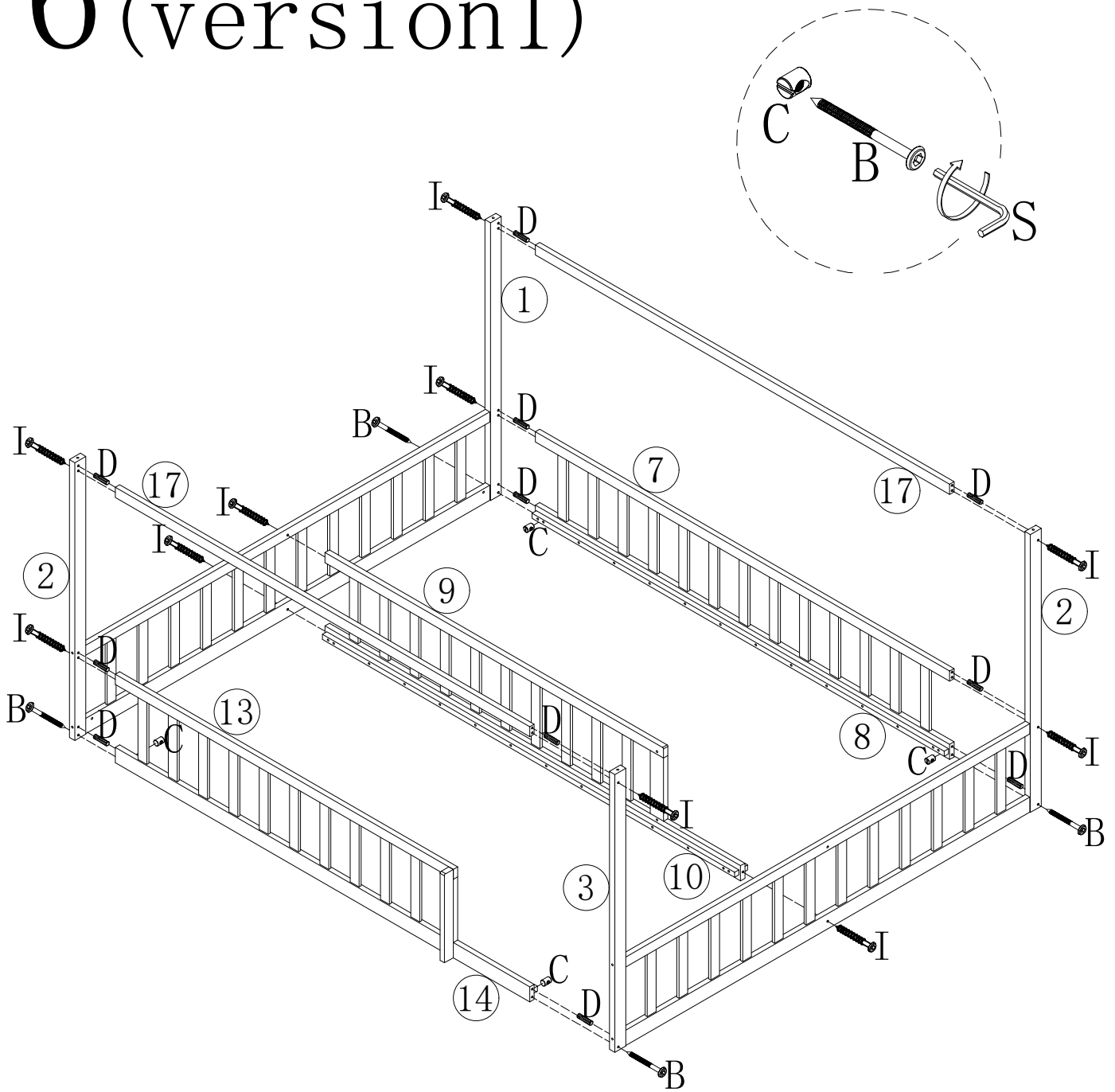

A	6x90		4PCS
C			4PCS
D	Ø8x30		8PCS
H	6x90		4PCS
S	M4		1PC

MONTAGEANLEITUNG/ASSEMBLY INSTRUCTIONS

6 (version1)





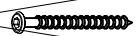

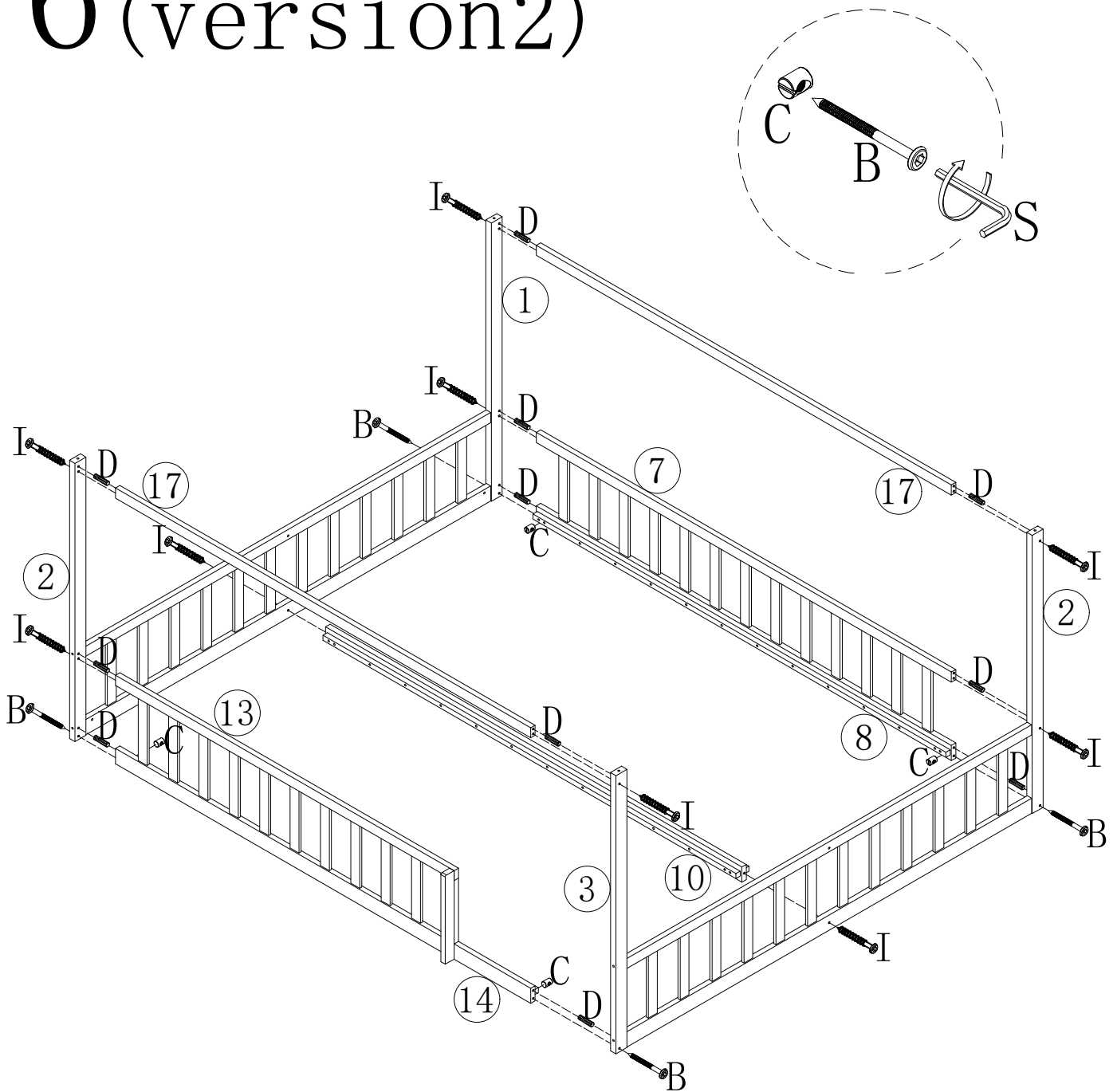

B	6x70		4PCS
C			4PCS
D	Ø8x30		10PCS
I	6x70		10PCS
S	M4		1PC

A	6x90	
H	6x90	

MONTAGEANLEITUNG/ASSEMBLY INSTRUCTIONS

6 (version2)





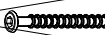

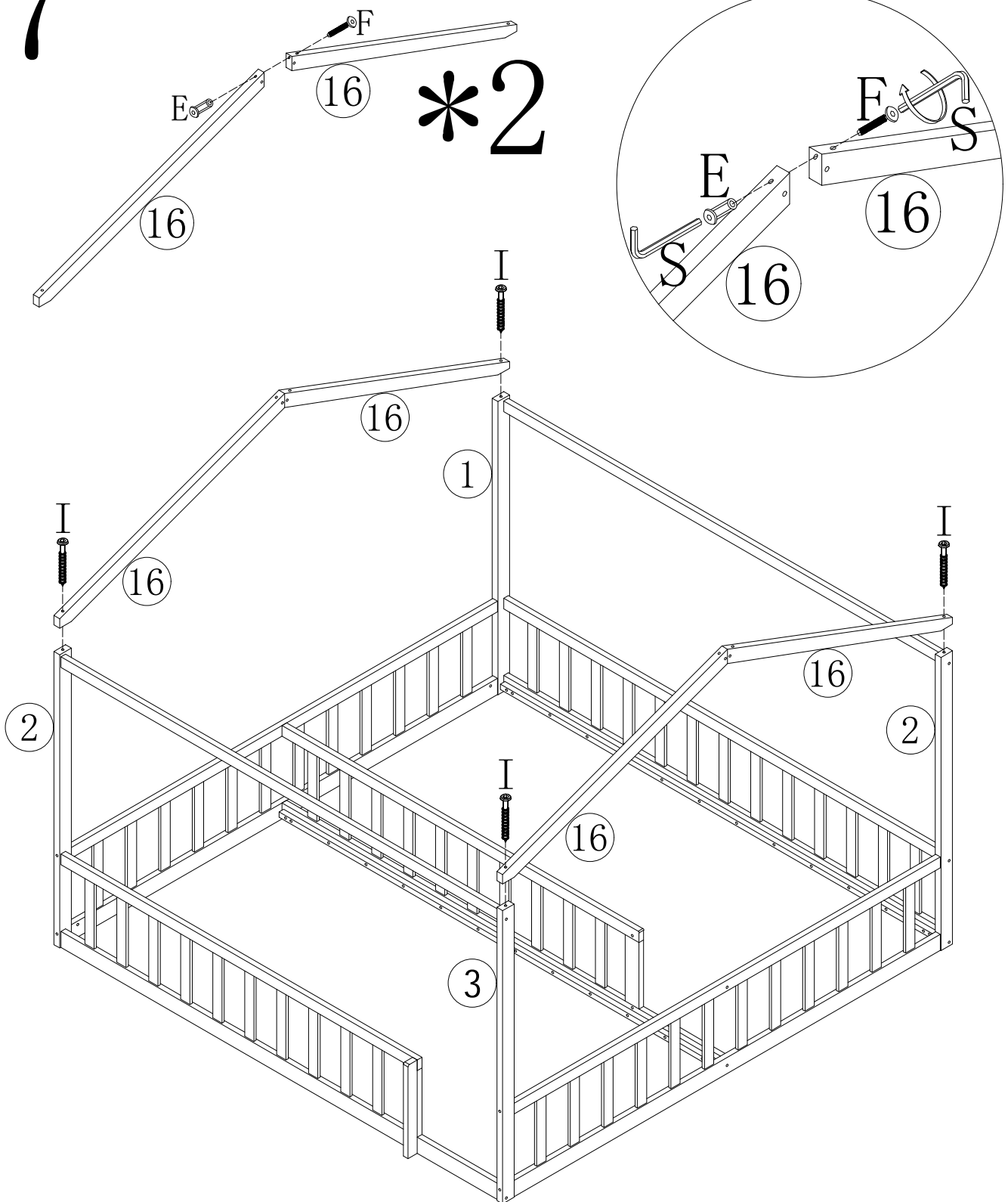

B	6x70		4PCS
C			4PCS
D	Ø8x30		10PCS
I	6x70		9PCS
S	M4		1PC

A	6x90	
H	6x90	

MONTAGEANLEITUNG/ASSEMBLY INSTRUCTIONS

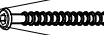
7



I	6x70		4PCS	H	6x90						
E	6x20		2PCS	F	6x30		2PCS	S	M4		2PCS

MONTAGEANLEITUNG/ASSEMBLY INSTRUCTIONS

8

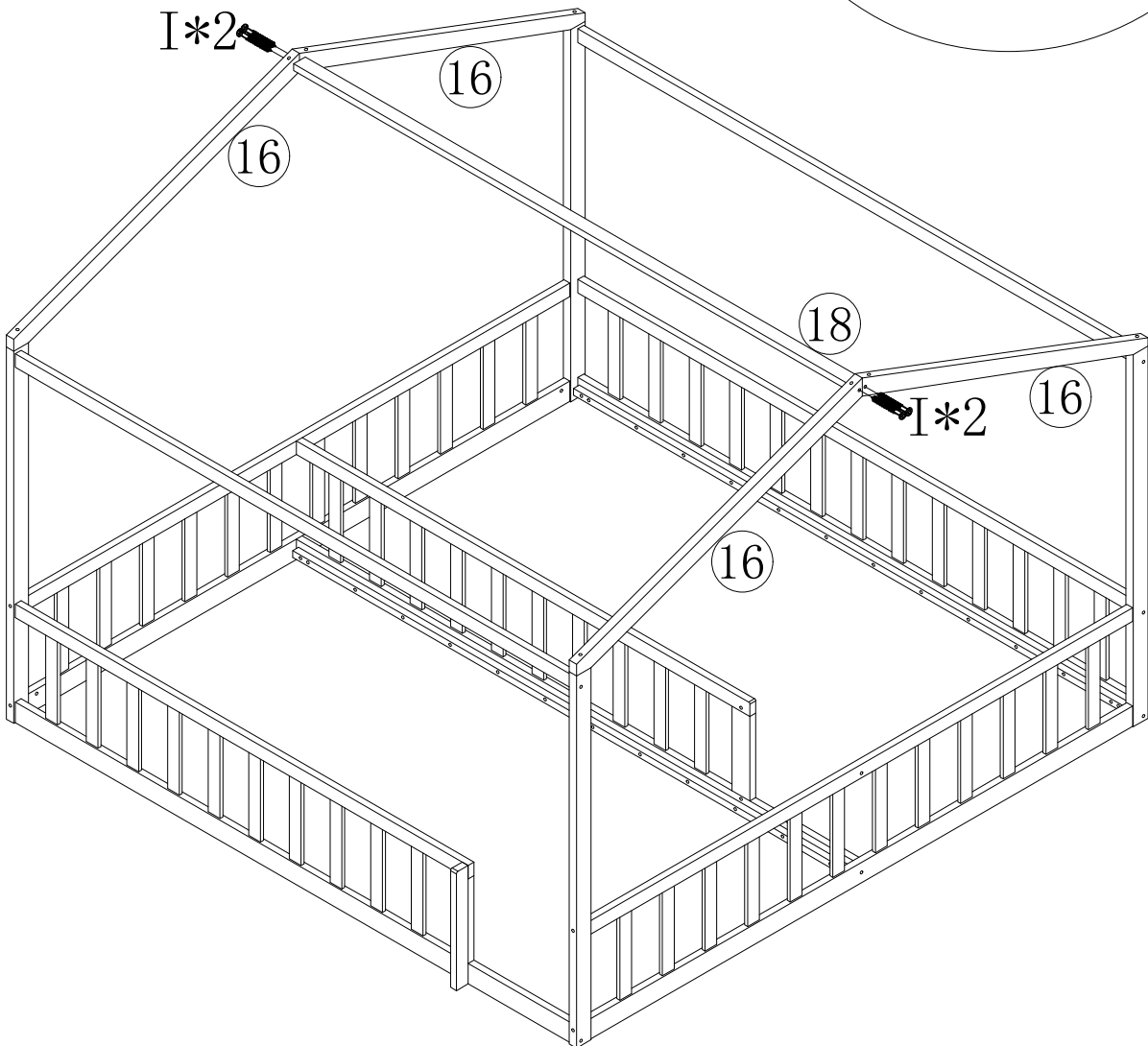
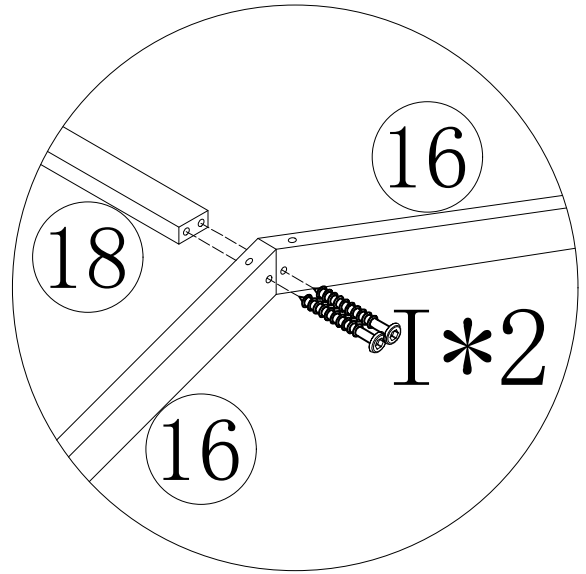

I	6x70		4PCS	S	M4		1PC	H	6x90	
---	------	---	------	---	----	---	-----	---	------	---

MONTAGEANLEITUNG/ASSEMBLY INSTRUCTIONS

9

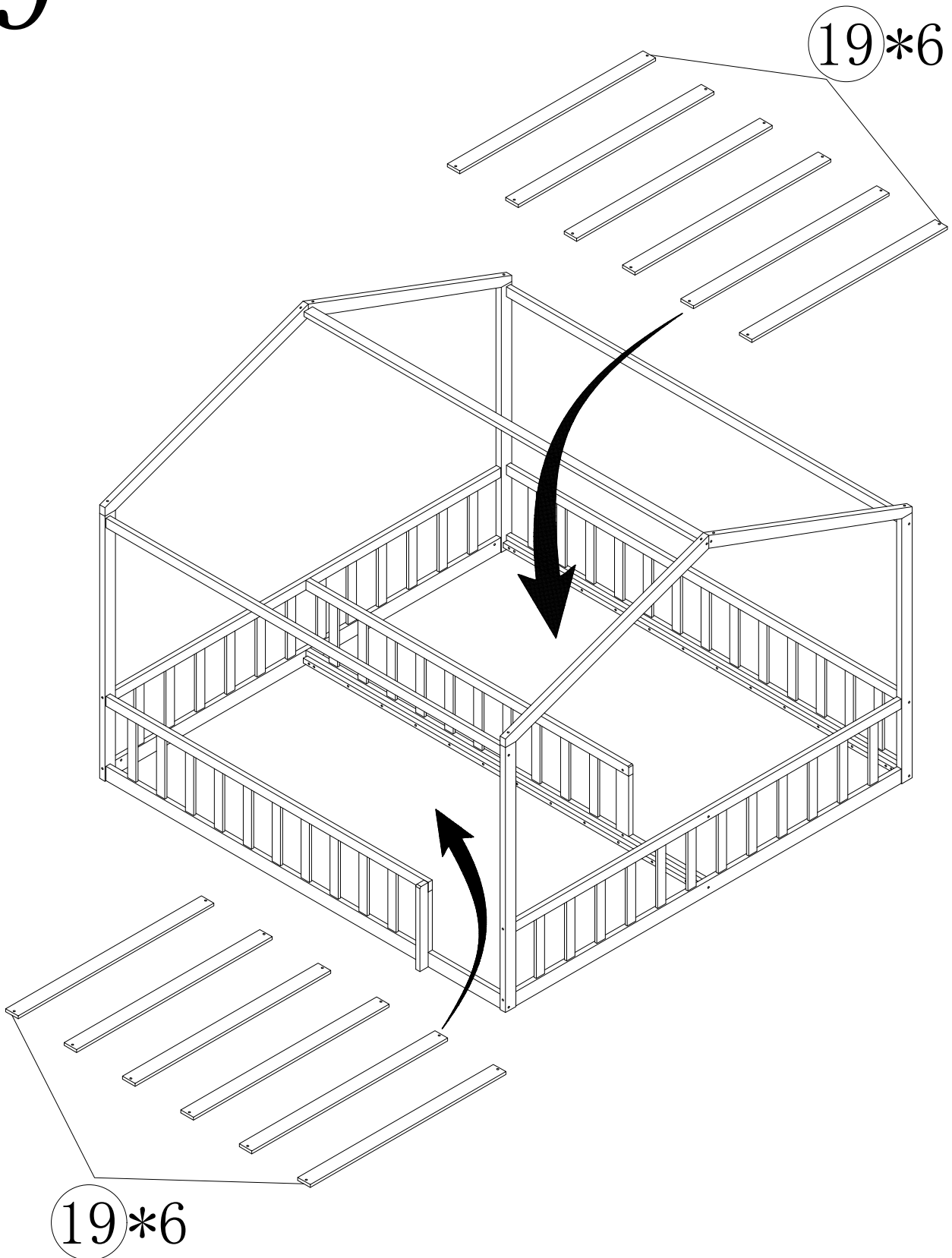

MONTAGEANLEITUNG/ASSEMBLY INSTRUCTIONS

10

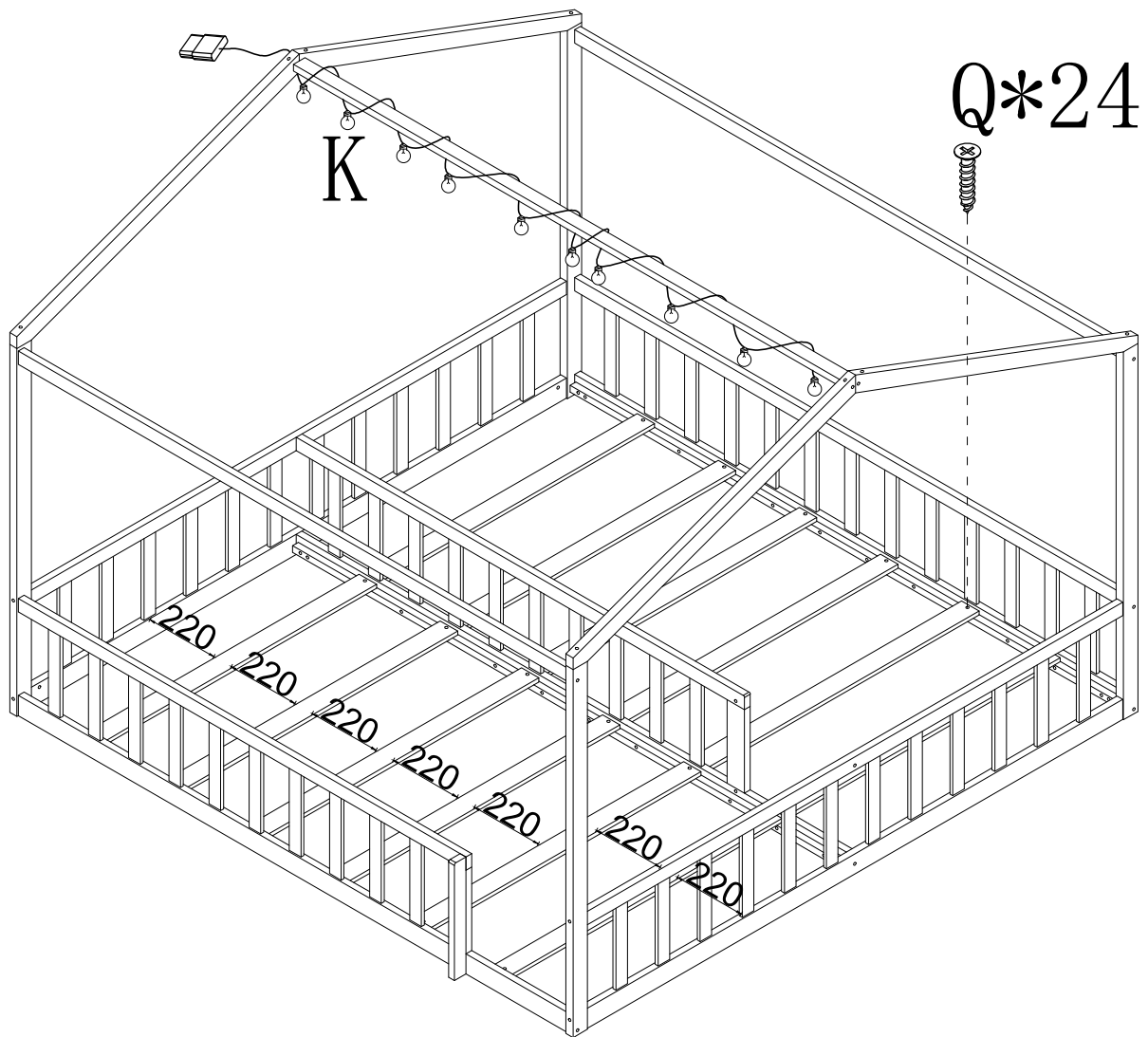

K



1PC

Q

3x25



24PCS



Certificate of Conformity

Certificate No. : STL2025E0306056C-Y1
Applicant : Linhai Hongteng Light Factory
Address : No.12-93 ,Xuanzhu Village, Dongcheng Town,Linhai City Taizhou City,Zhejiang Province,China
Manufacturer : Linhai Hongteng Light Factory
Address : No.12-93 ,Xuanzhu Village, Dongcheng Town,Linhai City Taizhou City,Zhejiang Province,China
Product Name : The LED straight-line lamp string
Trade Name : N/A
Model : HT-01/100,HT-01
Test Standards : EN IEC 55015:2019+A11:2020
EN 61547:2023
EN IEC 61000-3-2:2019+A1:2021+A2:2024
EN 61000-3-3:2013+A1:2019+A2:2021

The EUT described above has been tested by us with the listed standards and found in compliance with the council EMC directive 2014/30/EU. It is possible to use CE marking to demonstrate the compliance with this EMC directive.

CE



The results in this report are applicable only to the equipment tested. This report shall not be re-produced except in full without the written approval of Shenzhen STL Testing Technology Co., Ltd.

Shenzhen STL Testing Technology Co., Ltd.

Unit C, 4F, Building A, ShengHengji Industrial Park, No. 137 FuYuan 1 Road, Heping Community,
Fuyong Street, Baoan District, Shenzhen, China

Tel: +86-755-82593673 Fax: +86-755-82593673 <http://www.stl-test.com>



Certificate of Conformity

Certificate No. : STL2025R0306058C-Y1
Applicant : Linhai Hongteng Light Factory
Address : No.12-93 ,Xuanzhu Village, Dongcheng Town,Linhai City Taizhou City,Zhejiang Province,China
Manufacturer : Linhai Hongteng Light Factory
Address : No.12-93 ,Xuanzhu Village, Dongcheng Town,Linhai City Taizhou City,Zhejiang Province,China
Product Name : The LED straight-line lamp string
Trade Name : N/A
Model : HT-01/100,HT-01
Test Standards : EN 62321-5:2014,EN62321-4:2014+A1:2017,EN 62321-7-1:2015
EN 62321-7-2:2017,IEC 62321-6:2015,IEC 62321-8:2017

The Certificate of Compliance is based on a test procedure or an evaluation of the above-mentioned product. This is to certify that the above-mentioned product is in compliance with the **RoHS 2.0** Directive -2011/65/EU Annex II (EU) 2015/863 as last amended by Directive(EU) 2017/2102.

RoHS



The results in this report are applicable only to the equipment tested. This report shall not be re-produced except in full without the written approval of Shenzhen STL Testing Technology Co., Ltd.

Shenzhen STL Testing Technology Co., Ltd.
Unit C, 4F, Building A, ShengHengji Industrial Park, No. 137 FuYuan 1 Road, Heping Community,
Fuyong Street, Baoan District, Shenzhen, China

Tel: +86-755-82593673 Fax: +86-755-82593673 <http://www.stl-test.com>